

Big City Plus - Berlin Plus

Playdale
Playgrounds



Option A
Dark Blue & Orange
(shown)

Option B
Purple & Yellow

Option C
All Green

A junior modular tower system comprising of:

- 2 x Square Towers (1.9m)
- 2 x Triangular Towers (1.5m)
- Square Tower (1.1m)
- Slide (1.9m)
- Twisted Climbing Net (1.9m)
- Climbing Wall (1.9m)
- Side Ladder (1.9m)
- Rope Climb (1.5m)
- Fireman's Pole (1.5m)
- Side Climber (1.1m)
- Pole Slide (1.1m)
- Inclusive Net Access
- Inclined Net Bridge
- Curved Bridge (No Handles)
- Spinner
- Spider's Web
- Inclined Bridge with Net Ring
- Ball Blast 2 Player Play Panel
- Ball Blast Above Play Panel
- Bubble Above Play Panel

Code – BC/BER*3

Age

5-12 years

Materials

Stainless Steel

Compact Grade Laminate (CGL)

Nylon Steel Cored Rope

Various Plastic Mouldings

LLDPE Slide

Technical Information

Equipment Dimensions

Length / Width / Height **11.3m x 9.3m x 3.5m**

Surfacing and Area Required

Recommended Minimum Space
L/W/H **15.2m x 12.9m x 4.7m**

Max Gradient of Ground **1 in 50**

Free Height of Fall **1.9m**

Impact Area **105.74m²**

Synthetic Area
(i.e. EPDM / Wet Pour / Synthetic Grass etc.) **108.67m²**

Loosefill at 250mm
(i.e. Bark / Cushionfall / Sand) **32m³**

GrassLok Tiles **135m²**

Installation Information

SGF

SF (if different)

Installation Time **2 Persons 39 Hours**

Overall Weight **1650kg**

Heaviest Part **44kg**

Largest Part **3.7m x 0.4m x 0.4m**

Longest Part **3.7m**

Concrete Required **1.95m³** **3.01m³**

Certified to ASTM F1487

[Click here for more information & downloads](#)



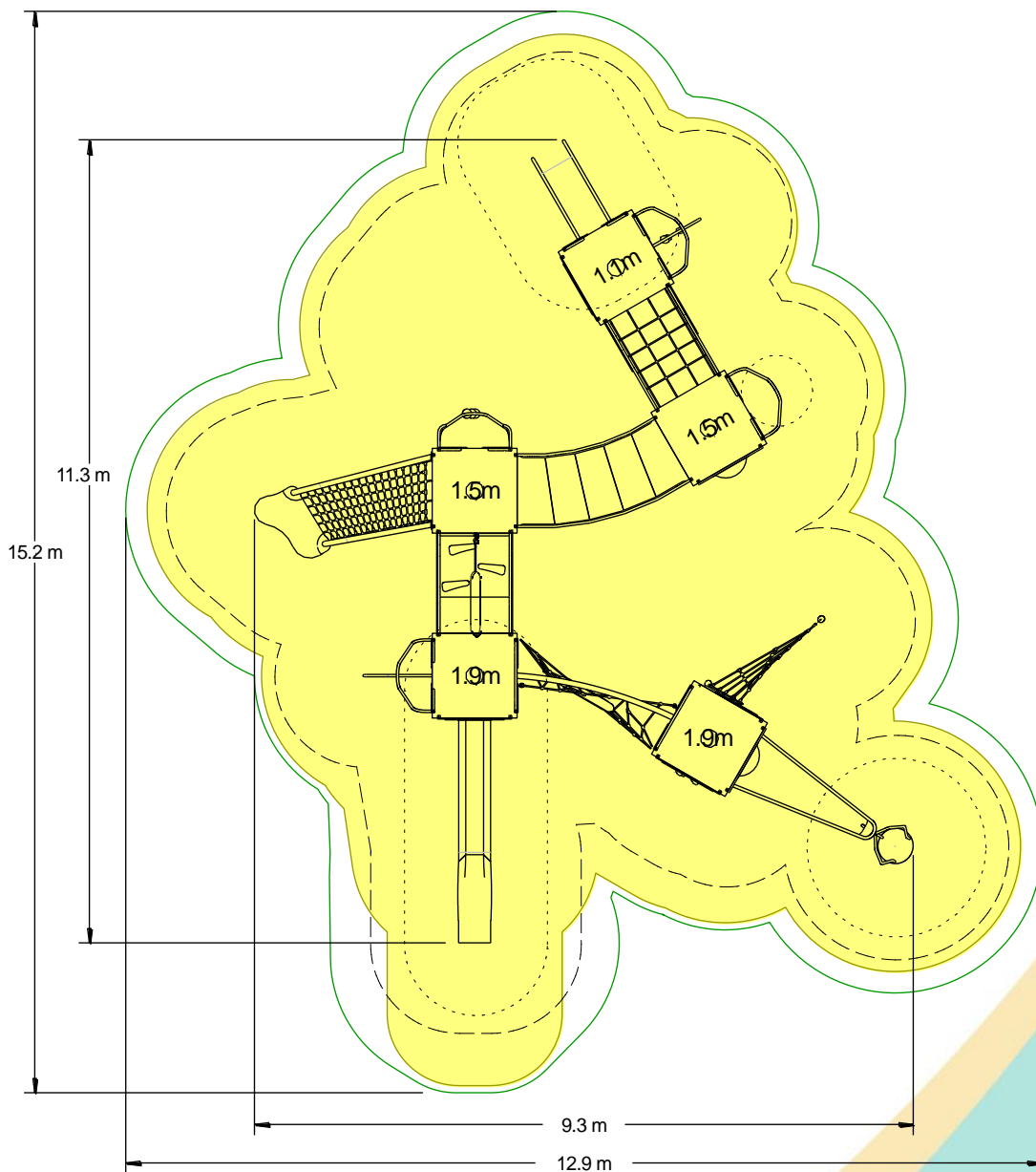
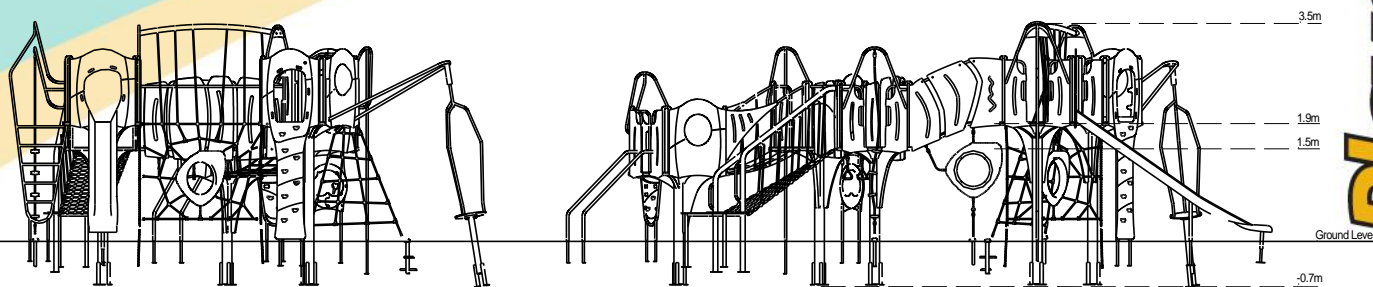

-  Recommended Minimum Space
-  Impact Area
-  Free Space
-  Unit Spacing Boundary

[Click here for more information & downloads](#)

